

# SET 140-1(L); SET 140-1(R); SET 160-1(L); SET 160-1(R)

1

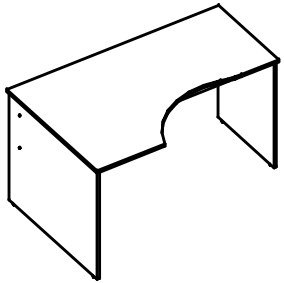

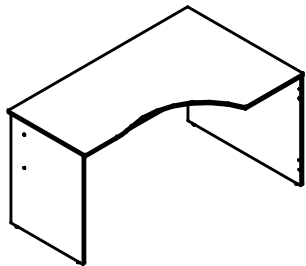





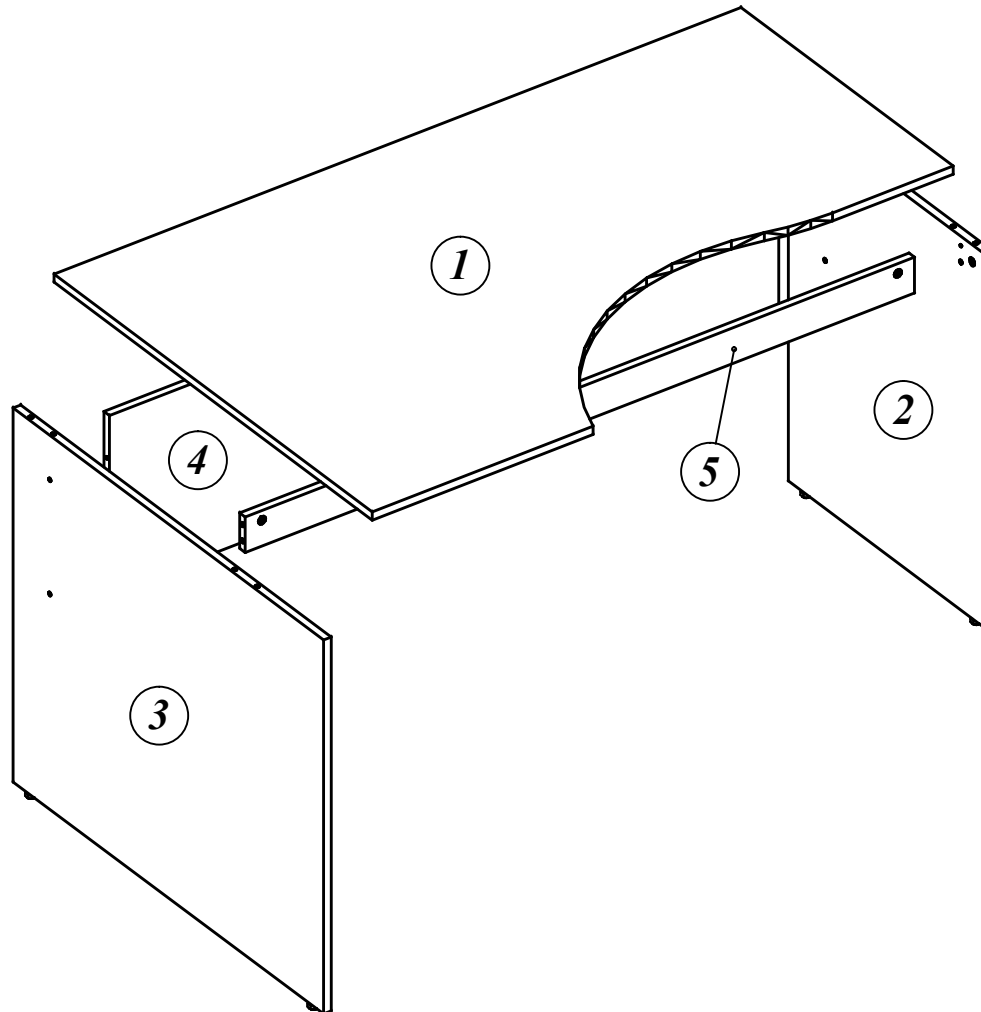



SET 140-1(L) - 1400x900x760  
SET 160-1(L) - 1600x900x760



SET 140-1(R) - 1400x900x760  
SET 160-1(R) - 1600x900x760



1		x4
2		x4
3		x4
4		x12
5		x4
6		x4
7		x4
8		x4
9		x1
10		x2
11		x8

**EAC**

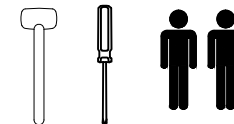

**SET 140-1(L); SET 140-1(R); SET 160-1(L); SET 160-1(R)**

